

NHD-1.5-128128ASC3

Graphic Color OLED Display Module

NHD-	Newhaven Display
1.5-	1.5" Diagonal Size
128128-	128 x 128 Pixels
AS-	Model
C-	Full Color
3-	+3.3V Power Supply

Newhaven Display International, Inc.

2661 Galvin Ct.

Elgin IL, 60124

Ph: 847-844-8795

Fax: 847-844-8796

www.newhavendisplay.com

nhtech@newhavendisplay.com

nhsales@newhavendisplay.com

Document Revision History

Revision	Date	Description	Changed by
0	11/19/2015	Initial Release	PB
1	1/11/2016	Functions and Features Updated	PB

Functions and Features

- 128 x 128 pixel resolution
- Built-in SSD1351 controller
- SPI MPU interface
- RoHS compliant
- microSD card reader (microSD card not included)
- Breadboard friendly
- Built-in logic level shifting for 3.3V ~ 5V operation

Mechanical Drawing

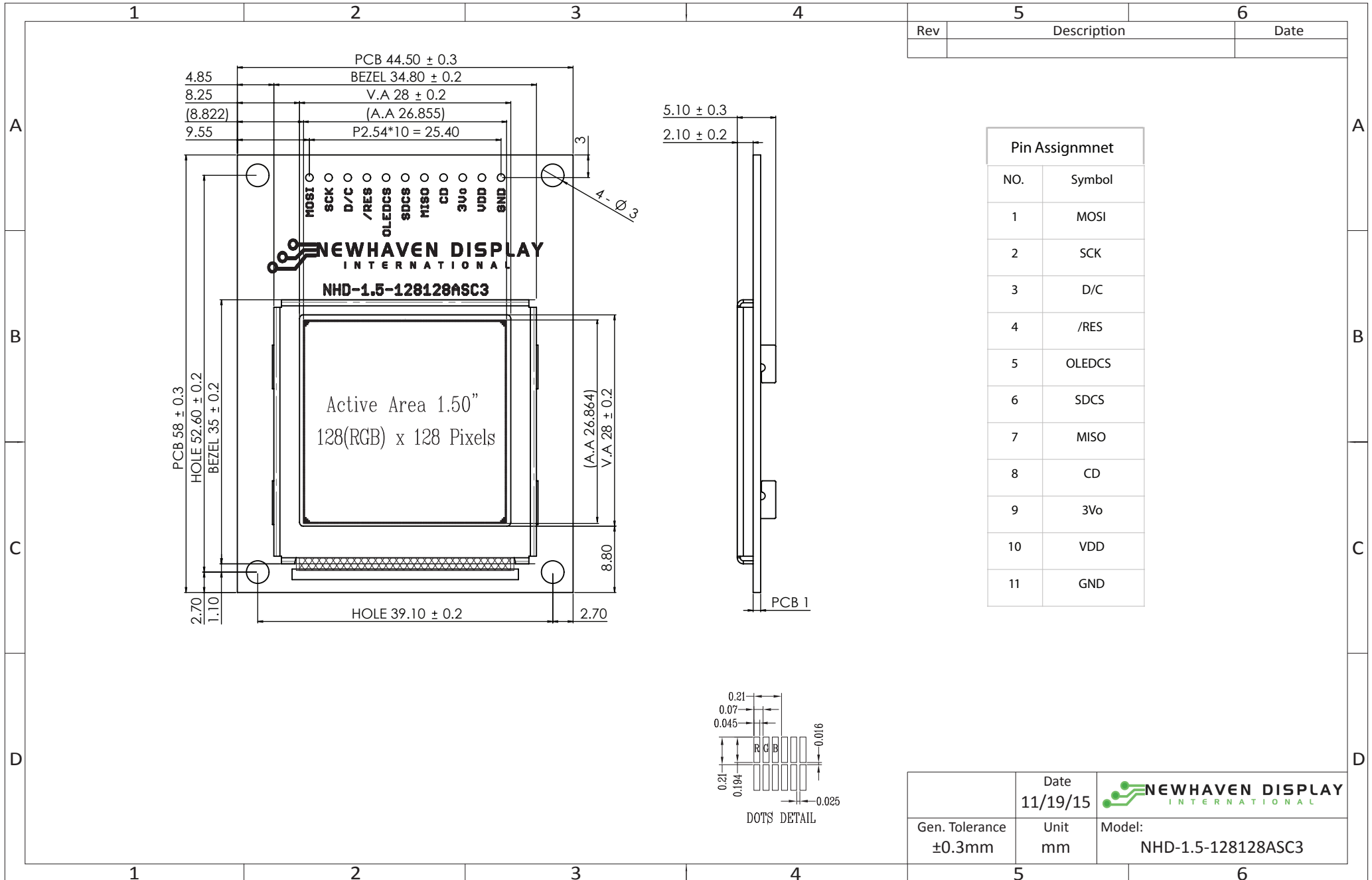

Schematic

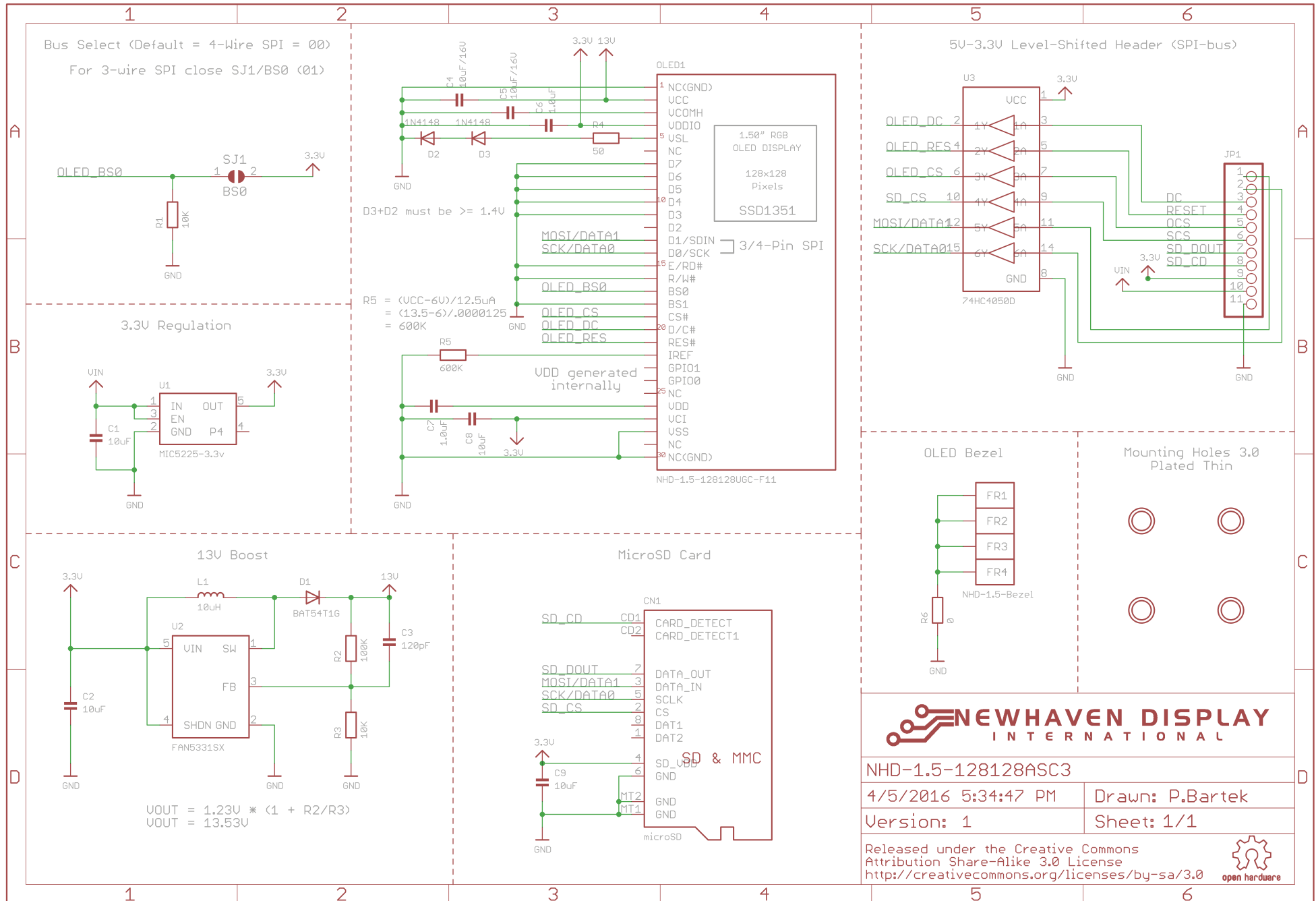

Interface Description

Pin No.	Symbol	External Connection	Function Description
1	MOSI	MPU	Master Out Slave In
2	SCK	MPU	Serial Clock signal
3	D/C	MPU	Register Select signal. D/C=0: Command, D/C=1: Data
4	/RES	MPU	Active LOW Reset signal
5	OLEDCS	MPU	OLED Active LOW Chip Select signal
6	SDCS	MPU	Micro SD Active LOW Chip Select signal
7	MISO	MPU	Master In / Slave Out
8	CD	MPU	Card Detect. Connect a 10K ohm pull-up resistor between this pin and a GPIO on the MPU to detect microSD card. This pin shorts to ground when microSD card is present.
9	3Vo	Power Supply	3.3V Output (No Connect)
10	VDD	Power Supply	Supply Voltage for OLED and logic (3.3V~5V)
11	GND	Power Supply	Ground

Jumper Communication Selection

Solder Jumper Name	4-wire Serial Interface	3-wire Serial Interface
SJ1	Open (default)	Short

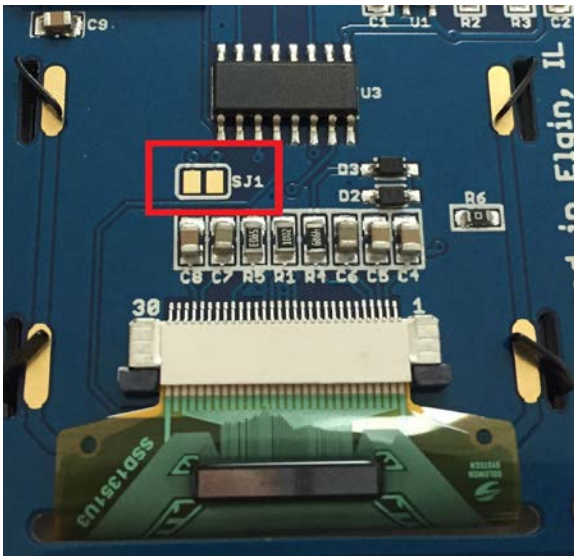

MPU Interface Pin Assignment Summary

Bus Interface	Data/Command Interface			Control Signals				
	MOSI	MISO	SCK	D/C	/RES	OLEDCS	SDCS	CD
4-wire SPI (default)	MOSI	MISO	SCK	D/C	/RES	OLEDCS	SDCS	CD
3-wire SPI	MOSI	MISO	SCK	Tie Low	/RES	OLEDCS	SDCS	CD

Wiring Diagrams

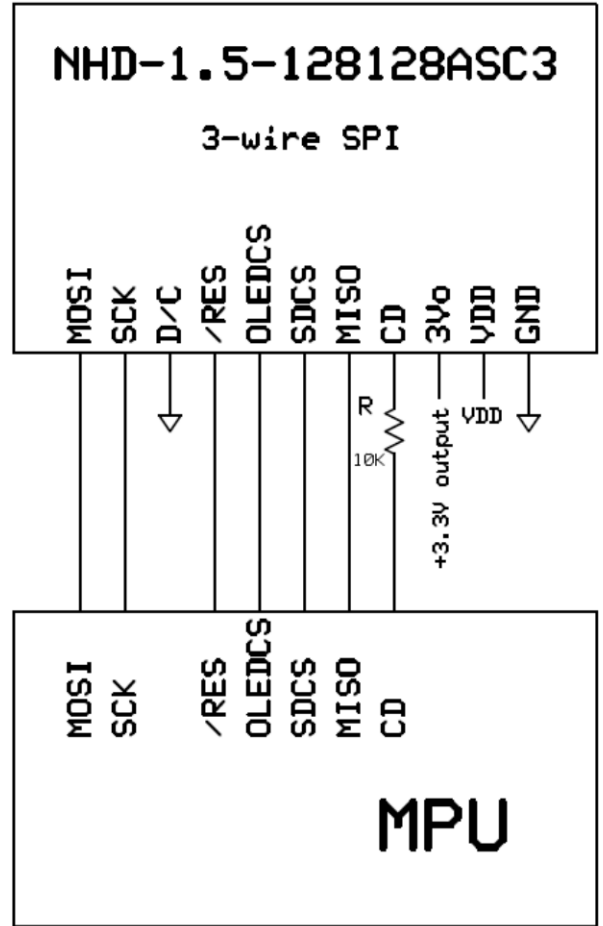
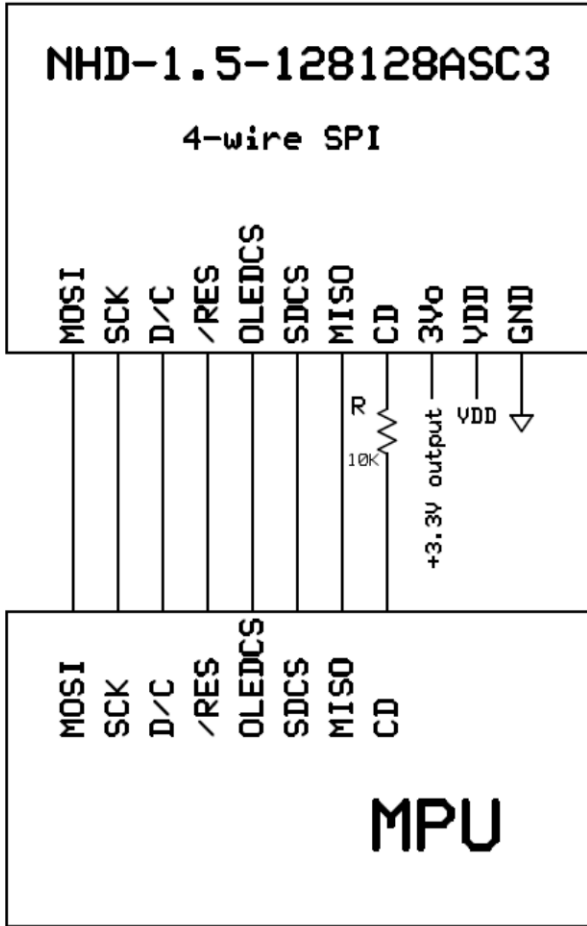

Electrical Characteristics

Item	Symbol	Condition	Min.	Typ.	Max.	Unit
Operating Temperature Range	TOP	Absolute Max	-30	-	+70	°C
Storage Temperature Range	Tst	Absolute Max	-40	-	+80	°C
Supply Voltage	VDD		3.0	3.3	5.5	V
Supply Current	IDD		-	85	200	mA
Sleep Mode Current	IDD _{SLEEP}		-	2	10	μA
"H" Level input	Vih		0.8*VDD	-	VDD	V
"L" Level input	Vil		0	-	0.2*VDD	V
"H" Level output	Voh		0.9*VDD	-	VDD	V
"L" Level output	Vol		0	-	0.1*VDD	V

Optical Characteristics

Item	Symbol	Condition	Min.	Typ.	Max.	Unit
Viewing Angle – Top			80	-	-	°
Viewing Angle – Bottom			80	-	-	°
Viewing Angle – Left			80	-	-	°
Viewing Angle – Right			80	-	-	°
Contrast Ratio	Cr		-	2000:1	-	-
Response Time (rise)	Tr	-	-	10	-	us
Response Time (fall)	Tf	-	-	10	-	us
Brightness		50% checkerboard	70	90	-	cd/m ²
Lifetime		90 cd/m ² , Ta=25°C, 50% checkerboard	10,000	-	-	Hrs

Note: Lifetime at typical temperature is based on accelerated high-temperature operation. Lifetime is tested at average 50% pixels on and is rated as Hours until **Half-Brightness**. The Display OFF command can be used to extend the lifetime of the display.

Luminance of active pixels will degrade faster than inactive pixels. Residual (burn-in) images may occur. To avoid this, every pixel should be illuminated uniformly.

Controller information

Built-in SSD1351 controller.

Please download specification at www.newhavendisplay.com/app_notes/SSD1351.pdf

Table of Commands

(D/C# = 0, R/W#(WR#)= 0, E(RD#) = 1) unless specific setting is stated

Single byte command (D/C# = 0), Multiple byte command (D/C# = 0 for first byte, D/C# = 1 for other bytes)

Fundamental Command Table											
D/C#	Hex	D7	D6	D5	D4	D3	D2	D2	D0	Command	Description
0	15	0	0	0	1	0	1	0	1	Set Column Address	A[6:0]: Start Address. [reset=0] B[6:0]: End Address. [reset=127] Range from 0 to 127
1	A[6:0]	*	A ₆	A ₅	A ₄	A ₃	A ₂	A ₁	A ₀		
1	B[6:0]	*	B ₆	B ₅	B ₄	B ₃	B ₂	B ₁	B ₀		
0	75	0	1	1	1	0	1	0	1	Set Row Address	A[6:0]: Start Address. [reset=0] B[6:0]: End Address. [reset=127] Range from 0 to 127
1	A[6:0]	*	A ₆	A ₅	A ₄	A ₃	A ₂	A ₁	A ₀		
1	B[6:0]	*	B ₆	B ₅	B ₄	B ₃	B ₂	B ₁	B ₀		
0	5C	0	1	0	1	1	1	0	0	Write RAM Command	Enable MCU to write Data into RAM
0	5D	0	1	0	1	1	1	0	1	Read RAM Command	Enable MCU to read Data from RAM
0	A0	1	0	1	0	0	0	0	0	Set Re-map / Color Depth (Display RAM to Panel)	A[0]=0b, Horizontal address increment [reset] A[0]=1b, Vertical address increment
1	A[7:0]	A ₇	A ₆	A ₅	A ₄	A ₃	A ₂	A ₁	A ₀		A[1]=0b, Column address 0 is mapped to SEG0 [reset] A[1]=1b, Column address 127 is mapped to SEG0 A[2]=0b, Color sequence: A → B → C [reset] A[2]=1b, Color sequence is swapped: C → B → A A[3]=0b, Reserved A[3]=1b, Reserved A[4]=0b, Scan from COM0 to COM[N-1] [reset] A[4]=1b, Scan from COM[N-1] to COM0. Where N is the Multiplex ratio. A[5]=0b, Disable COM Split Odd Even A[5]=1b, Enable COM Split Odd Even [reset] A[7:6] Set Color Depth, 00b / 01b: 65k color [reset] 10b: 262k color 11b 262k color, 16-bit format 2 Refer to Table 8-8 for details

Fundamental Command Table											
D/C#	Hex	D7	D6	D5	D4	D3	D2	D1	D0	Command	Description
0 1	A1 A[6:0]	1 *	0 A ₆	1 A ₅	0 A ₄	0 A ₃	0 A ₂	0 A ₁	1 A ₀	Set Display Start Line	Set vertical scroll by RAM from 0~127. [reset=00h]
0 1	A2 A[6:0]	1 *	0 A ₆	1 A ₅	0 A ₄	0 A ₃	0 A ₂	1 A ₁	0 A ₀	Set Display Offset	Set vertical scroll by Row from 0-127. [reset=60h] Note (1) This command is locked by Command FDh by default. To unlock it, please refer to Command FDh.
0	A4~A7	1	0	1	0	0	1	X ₁	X ₀	Set Display Mode	A4h: All OFF A5h: All ON (All pixels have GS63) A6h : Reset to normal display [reset] A7h: Inverse Display (GS0 -> GS63, GS1 -> GS62,)
0 1	AB A[7:0]	1 A ₇	0 A ₆	1 0	0 0	1 0	0 0	1 0	1 A ₀	Function Selection	A[0]=0b, Select external V _{DD} A[0]=1b, Enable internal V _{DD} regulator [reset] A[7:6]=00b, Select 8-bit parallel interface [reset] A[7:6]=01b, Select 16-bit parallel interface A[7:6]=11b, Select 18-bit parallel interface
0	AD	1	0	1	0	1	1	0	1	NOP	Command for no operation.
0	AE~AF	1	0	1	0	1	1	1	X ₀	Set Sleep mode ON/OFF	AEh = Sleep mode On (Display OFF) AFh = Sleep mode OFF (Display ON)
0	B0	1	0	1	1	0	0	0	0	NOP	Command for no operation.
0 1	B1 A[7:0]	1 A ₇	0 A ₆	1 A ₅	1 A ₄	0 A ₃	0 A ₂	0 A ₁	1 A ₀	Set Reset (Phase 1) / Pre-charge (Phase 2) period	A[3:0] Phase 1 period of 5~31 DCLK(s) clocks [reset=0010b] A[3:0]: 0-1 invalid 2 = 5 DCLKs 3 = 7 DCLKs : 15 = 31DCLKs A[7:4] Phase 2 period of 3~15 DCLK(s) clocks [reset=1000b] A[7:4]: 0-2 invalid 3 = 3 DCLKs 4 = 4 DCLKs : 15 = 15DCLKs Note (1) 0 DCLK is invalid in phase 1 & phase 2 (2) This command is locked by Command FDh by default. To unlock it, please refer to Command FDh.

Fundamental Command Table																																					
D/C#	Hex	D7	D6	D5	D4	D3	D2	D1	D0	Command	Description																										
0	B2	1	0	1	1	0	0	1	0	Display Enhancement	A[7:0] = 00h, B[7:0] = 00h, C[7:0] = 00h normal [reset] A[7:0] = A4h, B[7:0] = 00h, C[7:0] = 00h enhance display performance																										
1	A[7:0]	A ₇	A ₆	A ₅	A ₄	A ₃	A ₂	A ₁	A ₀																												
1	B[7:0]	0	0	0	0	0	0	0	0																												
1	C[7:0]	0	0	0	0	0	0	0	0																												
0	B3	1	0	1	1	0	0	1	1	Front Clock Divider (DivSet)/ Oscillator Frequency	A[3:0] [reset=0001], divide by DIVSET where <table border="1"> <thead> <tr> <th>A[3:0]</th> <th>DIVSET</th> </tr> </thead> <tbody> <tr><td>0000</td><td>divide by 1</td></tr> <tr><td>0001</td><td>divide by 2</td></tr> <tr><td>0010</td><td>divide by 4</td></tr> <tr><td>0011</td><td>divide by 8</td></tr> <tr><td>0100</td><td>divide by 16</td></tr> <tr><td>0101</td><td>divide by 32</td></tr> <tr><td>0110</td><td>divide by 64</td></tr> <tr><td>0111</td><td>divide by 128</td></tr> <tr><td>1000</td><td>divide by 256</td></tr> <tr><td>1001</td><td>divide by 512</td></tr> <tr><td>1010</td><td>divide by 1024</td></tr> <tr><td>>=1011</td><td>invalid</td></tr> </tbody> </table> A[7:4] Oscillator frequency, frequency increases as level increases [reset=1101b] Note (1) This command is locked by Command FDh by default. To unlock it, please refer to Command FDh.	A[3:0]	DIVSET	0000	divide by 1	0001	divide by 2	0010	divide by 4	0011	divide by 8	0100	divide by 16	0101	divide by 32	0110	divide by 64	0111	divide by 128	1000	divide by 256	1001	divide by 512	1010	divide by 1024	>=1011	invalid
A[3:0]	DIVSET																																				
0000	divide by 1																																				
0001	divide by 2																																				
0010	divide by 4																																				
0011	divide by 8																																				
0100	divide by 16																																				
0101	divide by 32																																				
0110	divide by 64																																				
0111	divide by 128																																				
1000	divide by 256																																				
1001	divide by 512																																				
1010	divide by 1024																																				
>=1011	invalid																																				
1	A[7:0]	A ₇	A ₆	A ₅	A ₄	A ₃	A ₂	A ₁	A ₀																												
0	B4	1	0	1	1	0	1	0	0	Set Segment Low Voltage (VSL)	A[1:0]=00 External VSL [reset] A[1:0]=01,10,11 are invalid Note (1) When external VSL is enabled, in order to avoid distortion in display pattern, an external circuit is needed to connect between VSL and V _{SS} as shown in Figure 14-1.																										
1	A[7:0]	1	0	1	0	0	0	A ₁	A ₀																												
1	B[7:0]	1	0	1	1	0	1	0	1																												
1	C[7:0]	0	1	0	1	0	1	0	1																												
0	B5	1	0	1	1	0	1	0	1	Set GPIO	A[1:0] GPIO0: 00 pin HiZ, Input disabled 01 pin HiZ, Input enabled 10 pin output LOW [reset] 11 pin output HIGH A[3:2] GPIO1: 00 pin HiZ, Input disabled 01 pin HiZ, Input enabled 10 pin output LOW [reset] 11 pin output HIGH																										
1	A[3:0]	*	*	*	*	A ₃	A ₂	A ₁	A ₀																												
0	B6	1	0	1	1	0	1	0	0	Set Second Pre-charge Period	A[3:0] Set Second Pre-charge Period 0000b invalid 0001b 1 DCLKS 0010b 2 DCLKS 1000 8 DCLKS [reset] 1111 15 DCLKS																										
1	A[3:0]	*	*	*	*	A ₃	A ₂	A ₁	A ₀																												

Fundamental Command Table																													
D/C#	Hex	D7	D6	D5	D4	D3	D2	D1	D0	Command	Description																		
0	B8	1	0	1	1	1	0	0	0	Look Up Table for Gray Scale Pulse width	<p>The next 63 data bytes define Gray Scale (GS) Table by setting the gray scale pulse width in unit of DCLK's (ranges from 0d ~ 180d)</p> <p>A1[7:0]: Gamma Setting for GS1, A2[7:0]: Gamma Setting for GS2, : A62[7:0]: Gamma Setting for GS62, A63[7:0]: Gamma Setting for GS63</p> <p>Note ⁽¹⁾ 0 ≤ Setting of GS1 < Setting of GS2 < Setting of GS3..... < Setting of GS62 < Setting of GS63 ⁽²⁾ GS0 has only pre-charge but no current drive stages. ⁽³⁾ GS1 can be set as only pre-charge but no current drive stage by input gamma setting for GS1 equals 0.</p>																		
1	A1[7:0]	A1 ₇	A1 ₆	A1 ₅	A1 ₄	A1 ₃	A1 ₂	A1 ₁	A1 ₀																				
1	A2[7:0]	A2 ₇	A2 ₆	A2 ₅	A2 ₄	A2 ₃	A2 ₂	A2 ₁	A2 ₀																				
1																				
1																				
1																				
1	A62[7:0]	A62 ₇	A62 ₆	A62 ₅	A62 ₄	A62 ₃	A62 ₂	A62 ₁	A62 ₀																				
1	A63[7:0]	A63 ₇	A63 ₆	A63 ₅	A63 ₄	A63 ₃	A63 ₂	A63 ₁	A63 ₀																				
0	B9	1	0	1	1	1	0	0	1	Use Built-in Linear LUT [reset= linear]	Reset to default Look Up Table: GS1 = 0 DCLK GS2 = 2 DCLK GS3 = 4 DCLK GS4 = 6 DCLK ... GS62 = 122 DCLK GS63 = 124 DCLK																		
0	BB	1	0	1	1	1	0	1	1	Set Pre-charge voltage	Set pre-charge voltage level.[reset = 17h]																		
1	A[4:0]	0	0	0	A ₄	A ₃	A ₂	A ₁	A ₀																				
											<table border="1"> <thead> <tr> <th>A[4:0]</th> <th>Hex code</th> <th>pre-charge voltage</th> </tr> </thead> <tbody> <tr> <td>00000</td> <td>00h</td> <td>0.20 x V_{CC}</td> </tr> <tr> <td>:</td> <td>:</td> <td>:</td> </tr> <tr> <td>11111</td> <td>1Fh</td> <td>0.60 x V_{CC}</td> </tr> </tbody> </table> <p>Note ⁽¹⁾This command is locked by Command FDh by default. To unlock it, please refer to Command FDh.</p>	A[4:0]	Hex code	pre-charge voltage	00000	00h	0.20 x V _{CC}	:	:	:	11111	1Fh	0.60 x V _{CC}						
A[4:0]	Hex code	pre-charge voltage																											
00000	00h	0.20 x V _{CC}																											
:	:	:																											
11111	1Fh	0.60 x V _{CC}																											
0	BE	1	0	1	1	1	1	1	0	Set V _{COMH} Voltage	Set COM deselect voltage level [reset = 05h]																		
1	A[2:0]	0	0	0	0	0	A ₂	A ₁	A ₀																				
											<table border="1"> <thead> <tr> <th>A[2:0]</th> <th>Hex code</th> <th>V_{COMH}</th> </tr> </thead> <tbody> <tr> <td>000</td> <td>00h</td> <td>0.72 x V_{CC}</td> </tr> <tr> <td>:</td> <td>:</td> <td>:</td> </tr> <tr> <td>101</td> <td>05h</td> <td>0.82 x V_{CC} [reset]</td> </tr> <tr> <td>:</td> <td>:</td> <td>:</td> </tr> <tr> <td>111</td> <td>07h</td> <td>0.86 x V_{CC}</td> </tr> </tbody> </table> <p>Note ⁽¹⁾This command is locked by Command FDh by default. To unlock it, please refer to Command FDh.</p>	A[2:0]	Hex code	V _{COMH}	000	00h	0.72 x V _{CC}	:	:	:	101	05h	0.82 x V _{CC} [reset]	:	:	:	111	07h	0.86 x V _{CC}
A[2:0]	Hex code	V _{COMH}																											
000	00h	0.72 x V _{CC}																											
:	:	:																											
101	05h	0.82 x V _{CC} [reset]																											
:	:	:																											
111	07h	0.86 x V _{CC}																											

Fundamental Command Table											
D/C#	Hex	D7	D6	D5	D4	D3	D2	D1	D0	Command	Description
0	C1	1	1	0	0	0	0	0	1	Set Contrast Current for Color A,B,C	A[7:0] Contrast Value Color A [reset=10001010b]
1	A[7:0]	A ₇	A ₆	A ₅	A ₄	A ₃	A ₂	A ₁	A ₀		B[7:0] Contrast Value Color B [reset=01010001b]
1	B[7:0]	B ₇	B ₆	B ₅	B ₄	B ₃	B ₂	B ₁	B ₀		C[7:0] Contrast Value Color C [reset=10001010b]
1	C[7:0]	C ₇	C ₆	C ₅	C ₄	C ₃	C ₂	C ₁	C ₀		
0	C7	1	1	0	0	0	1	1	1	Master Contrast Current Control	A[3:0] :
1	A[3:0]	*	*	*	*	A ₃	A ₂	A ₁	A ₀		0000b reduce output currents for all colors to 1/16 0001b reduce output currents for all colors to 2/16 1110b reduce output currents for all colors to 15/16 1111b no change [reset]
0	CA	1	1	0	0	1	0	1	0	Set MUX Ratio	A[6:0] MUX ratio 16MUX ~ 128MUX, [reset=127], (Range from 15 to 127)
1	A[6:0]	0	A ₆	A ₅	A ₄	A ₃	A ₂	A ₁	A ₀		
0	D1	1	0	1	0	1	1	0	1	NOP	Command for No Operation
0	E3	1	1	1	0	0	0	1	1	NOP	Command for No Operation
0	FD	1	1	1	1	1	1	0	1	Set Command Lock	A[7:0]: MCU protection status [reset = 12h] A[7:0] = 12b, Unlock OLED driver IC MCU interface from entering command [reset] A[7:0] = 16b, Lock OLED driver IC MCU interface from entering command
1	A[7:0]	A ₇	A ₆	A ₅	A ₄	A ₃	A ₂	A ₁	A ₀		A[7:0] = B0b, Command A2,B1,B3,BB,BE,C1 inaccessible in both lock and unlock state [reset] A[7:0] = B1b, Command A2,B1,B3,BB,BE,C1 accessible if in unlock state
											Note (1) The locked OLED driver IC MCU interface prohibits all commands and memory access except the FDh command.

Note

(1) "*" stands for "Don't care".

Set (GAC) (D/C# = 0, R/W#(WR#)= 0, E(RD#) = 1) unless specific setting is stated

Single byte command (D/C# = 0), Multiple byte command (D/C# = 0 for first byte, D/C# = 1 for other bytes)

Graphic acceleration command										Command	Description
D/C#	Hex	D7	D6	D5	D4	D3	D2	D2	D0		
0	96	1	0	0	1	0	1	1	0		A[7:0] = 00000000b No scrolling
1	A[7:0]	A ₇	A ₆	A ₅	A ₄	A ₃	A ₂	A ₁	A ₀		A[7:0] = 00000001b to 00111111b Scroll towards SEG127 with 1 column offset
1	B[6:0]	0	B ₆	B ₅	B ₄	B ₃	B ₂	B ₁	B ₀		A[7:0] = 01000000b to 11111111b Scroll towards SEG0 with 1 column offset
1	C[7:0]	C ₇	C ₆	C ₅	C ₄	C ₃	C ₂	C ₁	C ₀		
1	D[6:0]	0	D ₆	D ₅	D ₄	D ₃	D ₂	D ₁	D ₀		B[6:0] : start row address
1	E[1:0]	0	0	0	0	0	0	E ₁	E ₀		C[7:0] : number of rows to be H-scrolled B+C ≤ 128
										Horizontal Scroll	D[6:0] : Reserved (reset=00h)
											E[1:0] : scrolling time interval 00b test mode 01b normal 10b slow 11b slowest
											Note (1) Operates during display ON.
0	9E	1	0	0	1	1	1	1	0	Stop Moving	Stop horizontal scroll
											Note (1) After sending 9Eh command to stop the scrolling action, the ram data needs to be rewritten
0	9F	1	0	0	1	1	1	1	1	Start Moving	Start horizontal scroll

Note

(1) After executed the graphic command, waiting time is required for update GDDRAM content.

V_{CI} = 2.4~3.5V, waiting time = 500ns/pixel.

(2) “*” stands for “Don’t care”.

Timing Characteristics

4-wire SPI:

Symbol	Parameter	Min	Typ	Max	Unit
t_{cycle}	Clock Cycle Time	220	-	-	ns
t_{AS}	Address Setup Time	15	-	-	ns
t_{AH}	Address Hold Time	42	-	-	ns
t_{CSS}	Chip Select Setup Time	20	-	-	ns
t_{CSH}	Chip Select Hold Time	10	-	-	ns
t_{DSW}	Write Data Setup Time	15	-	-	ns
t_{DHW}	Write Data Hold Time	20	-	-	ns
t_{CLKL}	Clock Low Time	20	-	-	ns
t_{CLKH}	Clock High Time	20	-	-	ns
t_{R}	Rise Time	-	-	15	ns
t_{F}	Fall Time	-	-	15	ns

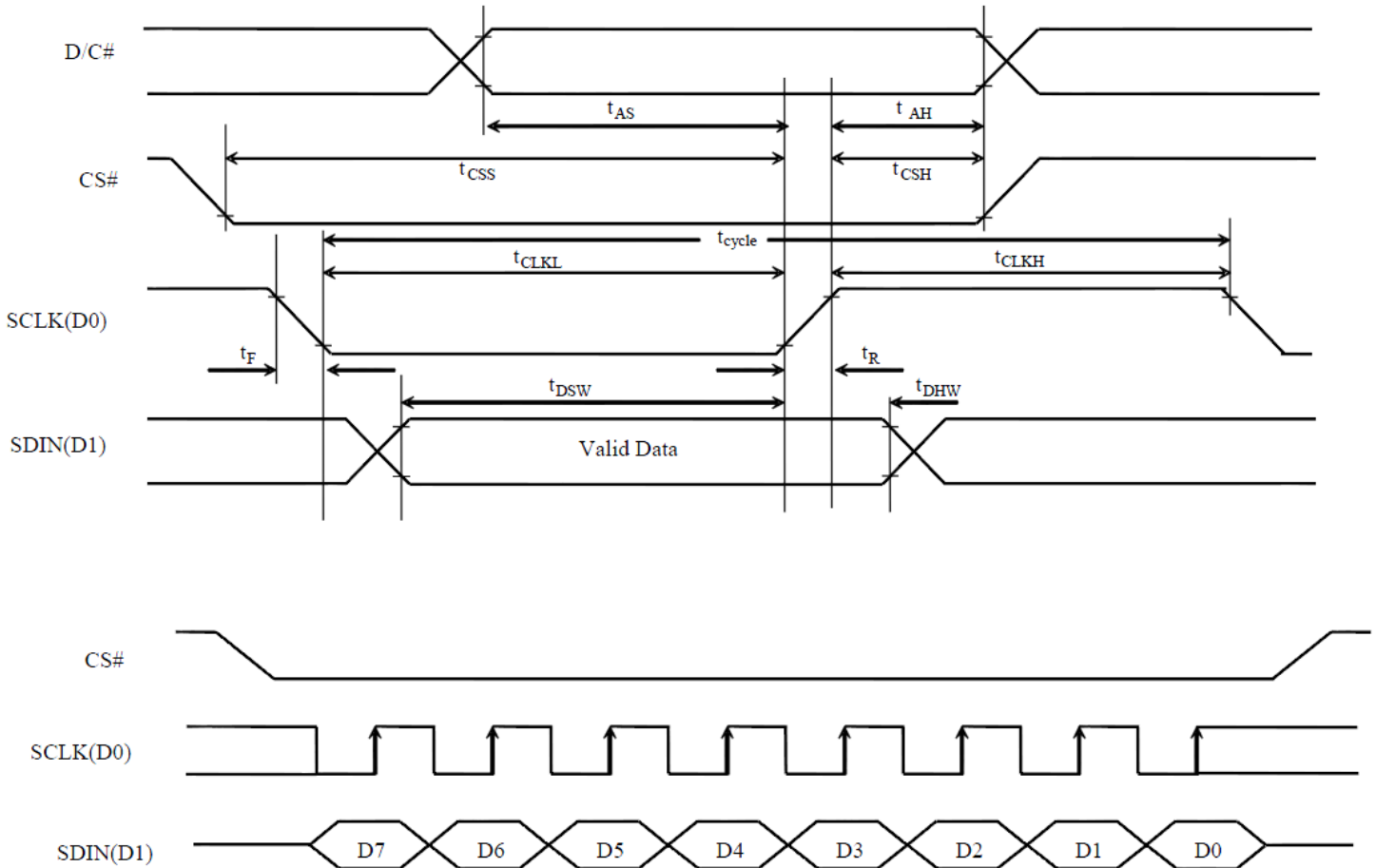

3-wire SPI:

Symbol	Parameter	Min	Typ	Max	Unit
t_{cycle}	Clock Cycle Time	220	-	-	ns
t_{CSS}	Chip Select Setup Time	20	-	-	ns
t_{CSH}	Chip Select Hold Time	44	-	-	ns
t_{DSW}	Write Data Setup Time	15	-	-	ns
t_{DHW}	Write Data Hold Time	20	-	-	ns
t_{CLKL}	Clock Low Time	20	-	-	ns
t_{CLKH}	Clock High Time	20	-	-	ns
t_{R}	Rise Time	-	-	15	ns
t_{F}	Fall Time	-	-	15	ns

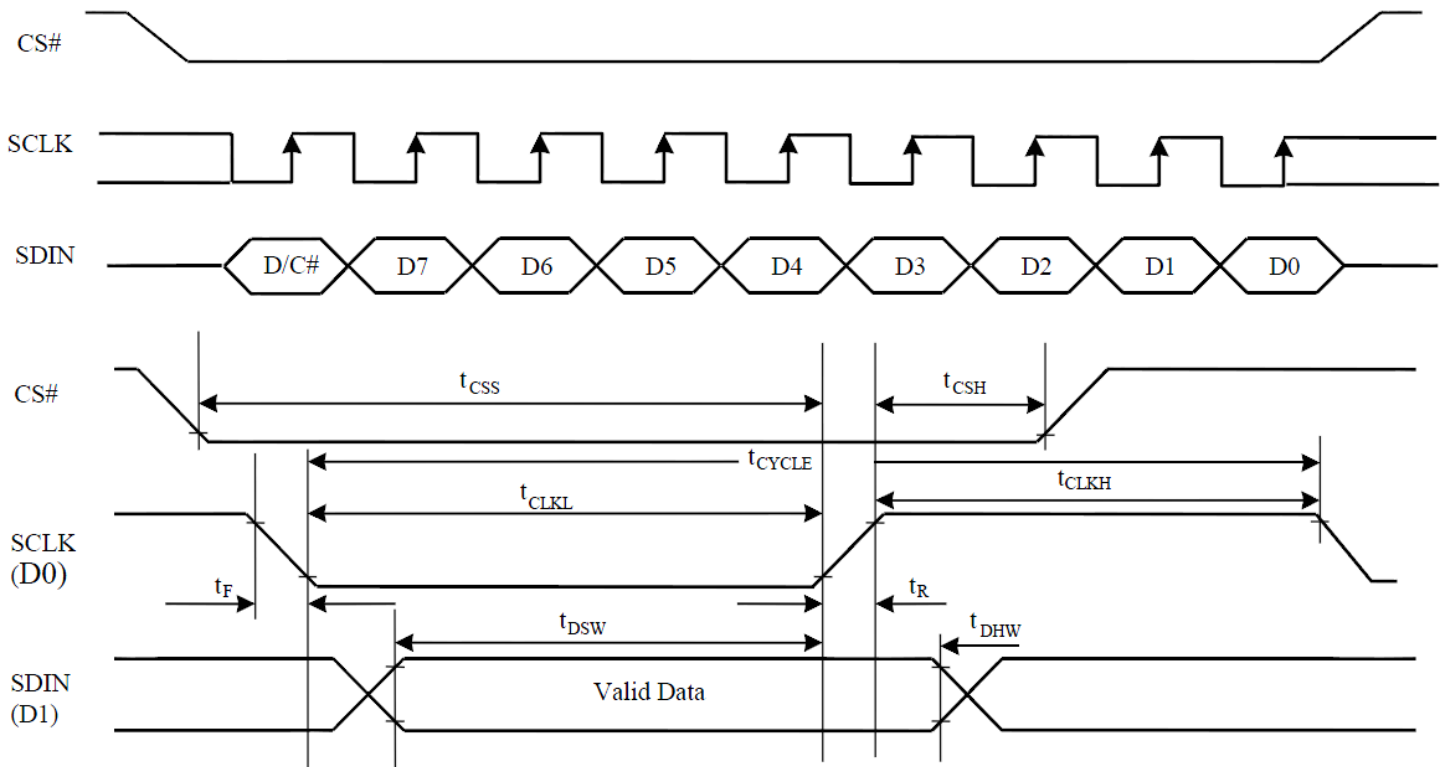

Example Initialization Sequence

```
void OLED_Init_128128RGB(void)
{
int i,j;
GPIO_ResetBits(GPIOC, RES);
graphic_delay(500000);
GPIO_SetBits(GPIOC, RES);
graphic_delay(500000);

oled_Command_128128RGB(0xFD); //Command lock setting
oled_Data_128128RGB(0x12); //unlock
oled_Command_128128RGB(0xFD); //Command lock setting
oled_Data_128128RGB(0xB1); //unlock

oled_Command_128128RGB(0xAE);

oled_Command_128128RGB(0xB3); //clock & frequency
oled_Data_128128RGB(0xF1); //clock=Diviser+1 frequency=fh

oled_Command_128128RGB(0xCA); //Duty
oled_Data_128128RGB(0x7F); //OLED_END+1

oled_Command_128128RGB(0xA2); //Display offset
oled_Data_128128RGB(0x00);

oled_Command_128128RGB(0xA1); //Set display start line
oled_Data_128128RGB(0x00); //0x00 start line

oled_Command_128128RGB(0xA0); //Set Re-map, color depth
oled_Data_128128RGB(0xA0); //8-bit 262K

oled_Command_128128RGB(0xB5); //set GPIO
oled_Data_128128RGB(0x00); //disabled

oled_Command_128128RGB(0xAB); //Function Set
oled_Data_128128RGB(0x01); //8-bit interface, internal VDD regulator

oled_Command_128128RGB(0xB4); //set VSL
oled_Data_128128RGB(0xA0); //external VSL
oled_Data_128128RGB(0xB5);
oled_Data_128128RGB(0x55);

oled_Command_128128RGB(0xC1); //Set contrast current for A,B,C
oled_Data_128128RGB(0x8a); //Color A //8a
oled_Data_128128RGB(0x51); //Color B //51
oled_Data_128128RGB(0x8a); //Color C //8a

oled_Command_128128RGB(0xC7); //Set master contrast
oled_Data_128128RGB(0x0F); //
```



```

oled_Command_128128RGB(0xB9); //use linear grayscale LUT

oled_Command_128128RGB(0xB1); //Set pre & dis-charge
oled_Data_128128RGB(0x32); //pre=1h, dis=1h

oled_Command_128128RGB(0xBB); //Set precharge voltage of color A,B,C
oled_Data_128128RGB(0x07); //

oled_Command_128128RGB(0xB2); //display enhancement
oled_Data_128128RGB(0xa4);
oled_Data_128128RGB(0x00);
oled_Data_128128RGB(0x00);

oled_Command_128128RGB(0xB6); //precharge period
oled_Data_128128RGB(0x01);

oled_Command_128128RGB(0xBE); //Set VcomH
oled_Data_128128RGB(0x07);

oled_Command_128128RGB(0xA6); //Normal display

oled_Command_128128RGB(0x15); //set column start and end addresses
oled_Data_128128RGB(0x00); //
oled_Data_128128RGB(0x7F); //
oled_Command_128128RGB(0x75); //set row start and end addresses
oled_Data_128128RGB(0x00); //
oled_Data_128128RGB(0x7F); //
oled_Command_128128RGB(0x5C); //write to RAM command

    for(i=0;i<128;i++)
    {
        for(j=0;j<128;j++)
        {
            oled_Data_128128RGB(0x00);
            oled_Data_128128RGB(0x00);
            oled_Data_128128RGB(0x00);
        }
    }
oled_Command_128128RGB(0xAF); //Display on
}

int oled_128128RGB(void)
{
column = 0x00;
byte1 = 0x00;
byte2 = 0x00;
oled_Command_128128RGB(0x15); //set column start and end addresses
oled_Data_128128RGB(column); //
oled_Data_128128RGB(0x7F); //

```

```

oled_Command_128128RGB(0x75);    //set row start and end addresses
oled_Data_128128RGB(0x00);      //
oled_Data_128128RGB(0x7F);      //
oled_Command_128128RGB(0x5C);    //write to RAM command

for (i=0;i<16384;i++)    //for each 24-bit pixel...128*128=16384
{
    f_read(&File1, &red, 1, &blen);    //read the red 8-bits
    f_read(&File1, &green, 1, &blen);    //read the green 8-bits
    f_read(&File1, &blue, 1, &blen);    //read the blue 8-bits

    red = red >> 2;
    green = green >> 2;
    blue = blue >> 2;
    oled_Data_128128RGB(red);
    oled_Data_128128RGB(green);
    oled_Data_128128RGB(blue);

}
////////////////////////////////////

```

Example Arduino Code

Please see: https://github.com/NewhavenDisplay/NHD-1.5-128128ASC3_Example

Quality Information

Test Item	Content of Test	Test Condition	Note
High Temperature storage	Test the endurance of the display at high storage temperature.	+80°C , 96hrs	2
Low Temperature storage	Test the endurance of the display at low storage temperature.	-40°C , 96hrs	1,2
High Temperature Operation	Test the endurance of the display by applying electric stress (voltage & current) at high temperature.	+70°C 96hrs	2
Low Temperature Operation	Test the endurance of the display by applying electric stress (voltage & current) at low temperature.	-30°C , 96hrs	1,2
High Temperature / Humidity Operation	Test the endurance of the display by applying electric stress (voltage & current) at high temperature with high humidity.	+60°C , 90% RH , 96hrs	1,2
Thermal Shock resistance	Test the endurance of the display by applying electric stress (voltage & current) during a cycle of low and high temperatures.	-30°C,30min -> 25°C,5min -> 70°C,30min = 1 cycle 100 cycles	
Vibration test	Test the endurance of the display by applying vibration to simulate transportation and use.	10-22Hz , 15mm amplitude. 22-500Hz, 1.5G 30min in each of 3 directions X,Y,Z	3
Atmospheric Pressure test	Test the endurance of the display by applying atmospheric pressure to simulate transportation by air.	115mbar, 40hrs	3
Static electricity test	Test the endurance of the display by applying electric static discharge.	VS=800V, RS=1.5kΩ, CS=100pF One time	

Note 1: No condensation to be observed.

Note 2: Conducted after 2 hours of storage at 25°C, 0%RH.

Note 3: Test performed on product itself, not inside a container.

Evaluation Criteria:

- 1: Display is fully functional during operational tests and after all tests, at room temperature.
- 2: No observable defects.
- 3: Luminance >50% of initial value.
- 4: Current consumption within 50% of initial value

Precautions for using OLEDs/LCDs/LCMs

See Precautions at www.newhavendisplay.com/specs/precautions.pdf

Warranty Information and Terms & Conditions

http://www.newhavendisplay.com/index.php?main_page=terms